

MPS5179

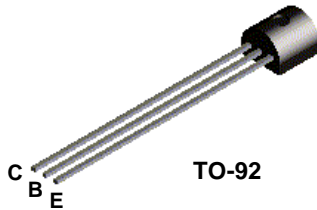

MMBT5179

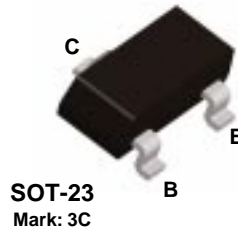

PN5179

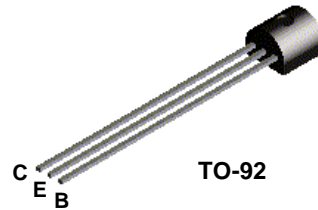

NPN RF Transistor

This device is designed for use in low noise UHF/VHF amplifiers with collector currents in the 100 μ A to 30 mA range in common emitter or common base mode of operation, and in low frequency drift, high output UHF oscillators. Sourced from Process 40.

Absolute Maximum Ratings*

TA = 25°C unless otherwise noted

Symbol	Parameter	Value	Units
V _{CEO}	Collector-Emitter Voltage	12	V
V _{CBO}	Collector-Base Voltage	20	V
V _{EBO}	Emitter-Base Voltage	2.5	V
I _C	Collector Current - Continuous	50	mA
T _J , T _{stg}	Operating and Storage Junction Temperature Range	-55 to +150	°C

*These ratings are limiting values above which the serviceability of any semiconductor device may be impaired.

NOTES:

- 1) These ratings are based on a maximum junction temperature of 150 degrees C.
- 2) These are steady state limits. The factory should be consulted on applications involving pulsed or low duty cycle operations.

Thermal Characteristics

TA = 25°C unless otherwise noted

Symbol	Characteristic	Max		Units
		PN/MPS5179	*MMBT5179	
P _D	Total Device Dissipation	350	225	mW
	Derate above 25°C	2.8	1.8	mW/°C
R _{θJA}	Thermal Resistance, Junction to Ambient	357	556	°C/W

*Device mounted on FR-4 PCB 1.6" X 1.6" X 0.06."

NPN RF Transistor
(continued)

MPS5179 / MMBT5179 / PN5179

Electrical Characteristics

TA = 25°C unless otherwise noted

Symbol	Parameter	Test Conditions	Min	Max	Units
--------	-----------	-----------------	-----	-----	-------

OFF CHARACTERISTICS

$V_{CE(sus)}$	Collector-Emitter Sustaining Voltage*	$I_C = 3.0 \text{ mA}, I_B = 0$	12		V
$V_{(BR)CBO}$	Collector-Base Breakdown Voltage	$I_C = 1.0 \text{ } \mu\text{A}, I_E = 0$	20		V
$V_{(BR)EBO}$	Emitter-Base Breakdown Voltage	$I_E = 10 \text{ } \mu\text{A}, I_C = 0$	2.5		V
I_{CBO}	Collector Cutoff Current	$V_{CB} = 15 \text{ V}, I_E = 0$ $V_{CB} = 15 \text{ V}, T_A = 150^\circ\text{C}$		0.02 1.0	μA μA

ON CHARACTERISTICS

h_{FE}	DC Current Gain	$I_C = 3.0 \text{ mA}, V_{CE} = 1.0 \text{ V}$	25	250	
$V_{CE(sat)}$	Collector-Emitter Saturation Voltage	$I_C = 10 \text{ mA}, I_B = 1.0 \text{ mA}$		0.4	V
$V_{BE(sat)}$	Base-Emitter Saturation Voltage	$I_C = 10 \text{ mA}, I_B = 1.0 \text{ mA}$		1.0	V

SMALL SIGNAL CHARACTERISTICS

f_T	Current Gain - Bandwidth Product	$I_C = 5.0 \text{ mA}, V_{CE} = 6.0 \text{ V},$ $f = 100 \text{ MHz}$	900	2000	MHz
C_{cb}	Collector-Base Capacitance	$V_{CB} = 10 \text{ V}, I_E = 0,$ $f = 0.1 \text{ to } 1.0 \text{ MHz}$		1.0	pF
h_{fe}	Small-Signal Current Gain	$I_C = 2.0 \text{ mA}, V_{CE} = 6.0 \text{ V},$ $f = 1.0 \text{ kHz}$	25	300	
$r_b' C_c$	Collector Base Time Constant	$I_C = 2.0 \text{ mA}, V_{CB} = 6.0 \text{ V},$ $f = 31.9 \text{ MHz}$	3.0	14	ps
NF	Noise Figure	$I_C = 1.5 \text{ mA}, V_{CE} = 6.0 \text{ V},$ $R_S = 50 \Omega, f = 200 \text{ MHz}$		5.0	dB

FUNCTIONAL TEST

G_{pe}	Amplifier Power Gain	$V_{CE} = 6.0 \text{ V}, I_C = 5.0 \text{ mA},$ $f = 200 \text{ MHz}$	15		dB
P_O	Power Output	$V_{CB} = 10 \text{ V}, I_E = 12 \text{ mA},$ $f \geq 500 \text{ MHz}$	20		mW

*Pulse Test: Pulse Width $\leq 300 \text{ } \mu\text{s}$, Duty Cycle $\leq 2.0\%$

Spice Model

NPN (Is=69.28E-18 Xti=3 Eg=1.11 Vaf=100 Bf=282.1 Ne=1.177 Ise=69.28E-18 Ikf=22.03m Xtb=1.5 Br=1.176 Nc=2 Isc=0 Ikr=0 Rc=4 Cjc=1.042p Mjc=.2468 Vjc=.75 Fc=.5 Cje=1.52p Mje=.3223 Vje=.75 Tr=1.588n Tf=135.6p Itf=.27 Vtf=10 Xtf=30 Rb=10)

DC Typical Characteristics

DC Current Gain vs Collector Current

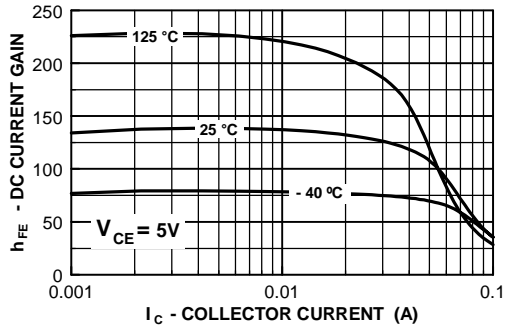

Collector-Emitter Saturation Voltage vs Collector Current

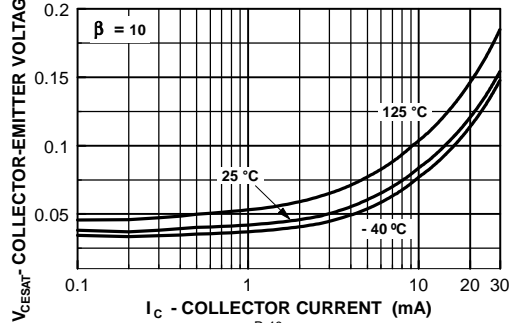

Base-Emitter Saturation Voltage vs Collector Current

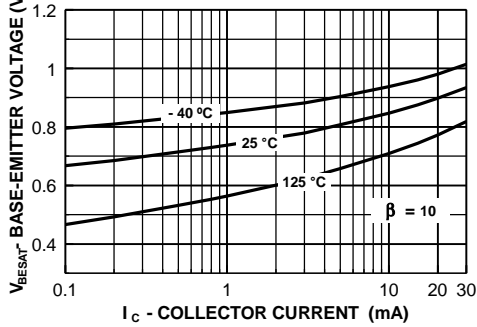

Base-Emitter ON Voltage vs Collector Current

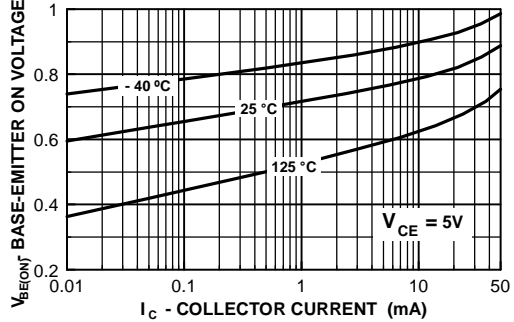

Collector-Cutoff Current vs Ambient Temperature

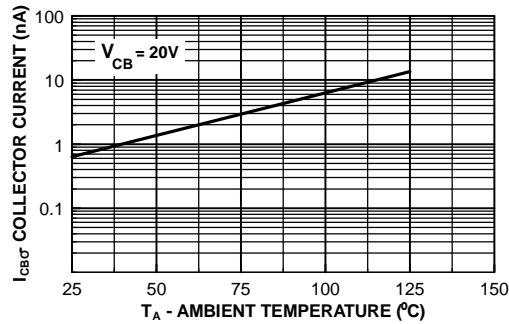

AC Typical Characteristics

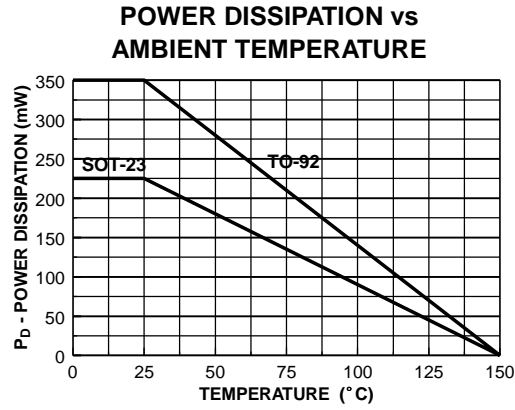

Test Circuit

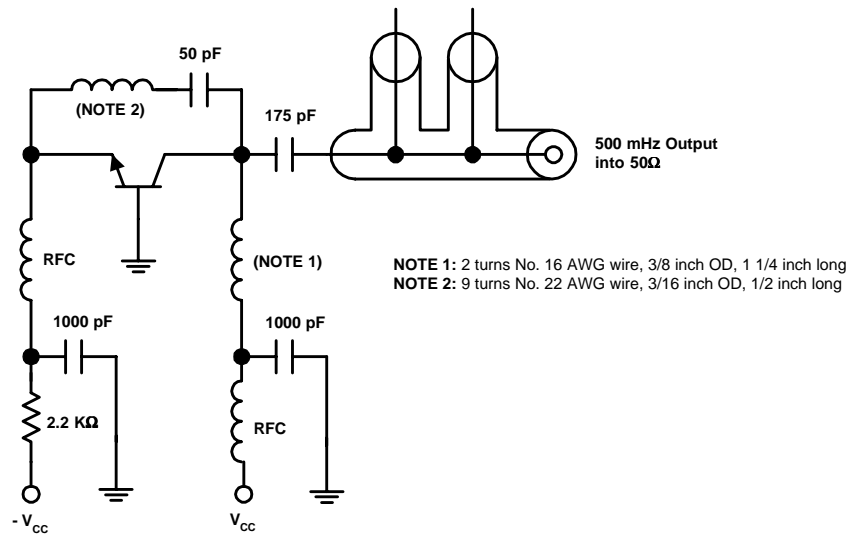

FIGURE 1: 500 MHz Oscillator Circuit